

**Model:** FKJ-B(PWM)-1.5KW48V(With 600W solar)

# PWM WIND SOLAR HYBRID CHARGE CONTROLLER

## §USER MANUAL§



★ Read the user manual carefully before use.

## Contents

<b>Overview.....</b>	<b>4</b>
<b>PWM model Product Characteristics.....</b>	<b>4</b>
<b>Pictures of controller.....</b>	<b>6</b>
<b>Usage.....</b>	<b>6</b>
<b>Operation Steps.....</b>	<b>7</b>
<b>Remove wiring step controller.....</b>	<b>8</b>
<b>Failure Analysis.....</b>	<b>11</b>
<b>Box diagram.....</b>	<b>11</b>
<b>Liquid crystal screen operation and display.....</b>	<b>12</b>
<b>Attentions.....</b>	<b>14</b>
<b>Maintenance of Battery.....</b>	<b>15</b>
<b>Functional Diagram.....</b>	<b>17</b>
<b>Wiring diagram.....</b>	<b>17</b>
<b>Technical Parameters.....</b>	<b>18</b>
<b>Particular Notice.....</b>	<b>19</b>

## The safety matter:

Please read this instruction book carefully before installation 、 running 、 maintenance or check-up.

As electronic product , it is all dangerous when touching the electricity part.



**warning: Dismantlement of the unloader in the use is forbidden. The unloader must be connected in accordance with the wiring diagram strictly. Otherwise the wind turbine will be damaged because loss of control and the controller will be damaged due to the over-high voltage!**



**Attention :this device must request that electrician make a install.**

## Using direction

- make sure read this instruction book carefully before appliance;
- The equipment must be installed by professionals;
- To avoid personal injury, make sure it must be a good ground connection when installation;
- Not running in humidity or temperature is too high, volatile gases or flammable environments;
- Against accidental use, to prevent power failures;
- When moving machines, please put down carefully;
- Open the package, Please check the attached, as found in or damaged in transit phenomenon, to contact with, you will get satisfactory service;
- If emerge the installation of equipment damage not following the handbook; , The firm is entitled not to a quality assurance.

## **IOverview**

Our company has been engaged in wind power generation for over 10 years and we made continuous updating relying on the practical experience for many years , referring to the relevant state standard and in accordance with the characteristics of wind power generation. Having perfect protective functions, this system runs safely with high work efficiency and long service life. It was selected as the designated product for many times by the state in the assistance project of exported wind energy.

## **II PWM model Product Characteristics**

- ◆ The product is manufactured according the JB/T6939.1-2004 industrial standard and GB/T 19115.1-2003 national standard also with users' technical requirements.
- ◆ The big screen LCD display. Clearly present the working status of the wind turbine, solar panel, battery and controller. ( Wind turbine voltage, current, power display ;solar voltage, current, power display, battery charging current, voltage, charging power, power display. )
- ◆ Two sets of control systems: PWM constant voltage system and three-phase dump load system.

- ◆ PWM constant voltage control is 120% of the rated power of the wind turbine . In case exceeding of PWM's capacity, the three-phase dump load will automatically start immediately to ensure safe running of the overall wind turbine system.
- ◆ Under the circumstances of disconnecting or damage of the battery, the three-phase dump load will start automatically to avoid the idling for wind turbine and the occurrence of runaway accident.
- ◆ Under the strong or super-strong wind conditions PWM control to ensure battery charged by the wind turbine with constant voltage and current.
- ◆ The protection function of reverse connection, disconnection and damage-resisting of the battery will be applied.
- ◆ Over-charging protection of the battery: When the battery is full (the battery voltage getting 125% of the rated voltage), the controller will carry out three-phase dump load automatically to stop charging the battery.
- ◆ Auto recharging of battery: When the battery voltage reduces to 108% of the rated voltage, it stops three-phase dump load to recharge battery automatically.
- ◆ For the different wind turbine type, the controller can be equipped with mechanical yawing, furled empennage, mechanical or hydraulic, pneumatic, electric magnetic and other brake functions.
- ◆ The inside of the controller is equipped with surge arrester. Contain the over voltage into the wind turbine under the bearable voltage of the equipment or system. On the other way, to conduct the strong lightning current into the earth directly to avoid any damage of equipment.
- ◆ Ammeter and voltmeter indication: Indicate the charging current and voltage of the battery.
- ◆ The controller is equipped with manual three-phase dump load switch. To using this switch, the wind turbine will carry out three-phase dump load forcibly.

### III Pictures of controller



### IV Usage

#### 1) External wire

- The positive electrode (+) and negative electrode (–) of the battery shall be connected with the terminals of the machine respectively without misconnection or short circuit.
- The three-phase output wires of the wind turbine shall be connected with the terminals on the backside of the controller respectively (the three-phase wires have no chronological order.)
- connect the solar panels with the solar +, - of the controller.
- Connect the PWM dump load terminal on the unloader with the PWM dump load terminal on the controller; (connect them in accordance with the wiring diagram strictly).

#### 2)

- When voltage of the battery is lower than the discharge lower limit (for details, see the attached table on the back), power shortage indicator is on to warn users that the battery is at the discharge lower limit. At this moment, stop using the

battery and charge the battery before it can be used again.

- When the fuse is blown, the fuse indicator is on to warn users to change the fuse.



- In operation of the wind turbine, opening the fuse or replacing the fuse is forbidden so as not to injure the personnel or damage the machine. Make the wind turbine in three-phase dump load state, when replacing the fuse; disconnect the connection switch of the battery group to check or replace the fuse pipe.

- When the battery is completely charged to 125% of the rated voltage, the controller will automatically brake the wind turbine and stop charging the battery, meanwhile, the over charge indicator is on. When voltage of the battery drops to 108% of the rated voltage, the over charge indicator is off and the wind turbine recovers to charge the battery.

### 3) Manual three-phase dump load switch

1. When the battery is connected correctly, place the switch of the wind turbine on the back plate on RUM, the wind turbine is in operation state.

2. When the machine is not in use or the wind is too strong or in dismantlement of the battery, loof the wind turbine, then place the switch of the wind turbine on STOP and make the wind turbine in three-phase dump load state.

## V Operation Steps

- 1) The automatic controller shall be strictly operated in accordance with the following operation steps when it is installed or maintained periodically.



1. Place the manual blower switch on STOP before operation and make the wind turbine group in three-phase dump load state.

2. After disconnecting the switch to connect the battery (or fuse), connect the battery group; misconnecting of positive electrode and negative electrode of the battery is forbidden.

3. Connect the unloader with the controller (see the wiring diagram);

4. Connect the three-phase wire of the wind turbine with the wind turbine

terminals on the controller;

5. Make the battery switch (or fuse) in connection state;
6. Make the wind turbine switch on RUN state.

 **2) Warning: install and operate the machine strictly in accordance with the operation steps.**

3) Operating environment

- The operating environment shall be dry, clean and well ventilated.
- Operating environment which is under direct sunlight, exposed to sunshine, humid and full of acid mist is forbidden.
- Operating environment which has dust and dirt is forbidden;

 Put the machine in dry place and cover it with dust cover; put it in place with good ventilation and heat dissipation;

 Operating environment which has flammable and explosive gas is forbidden and be cautious of sparks.

## **VI Installation Diagram**



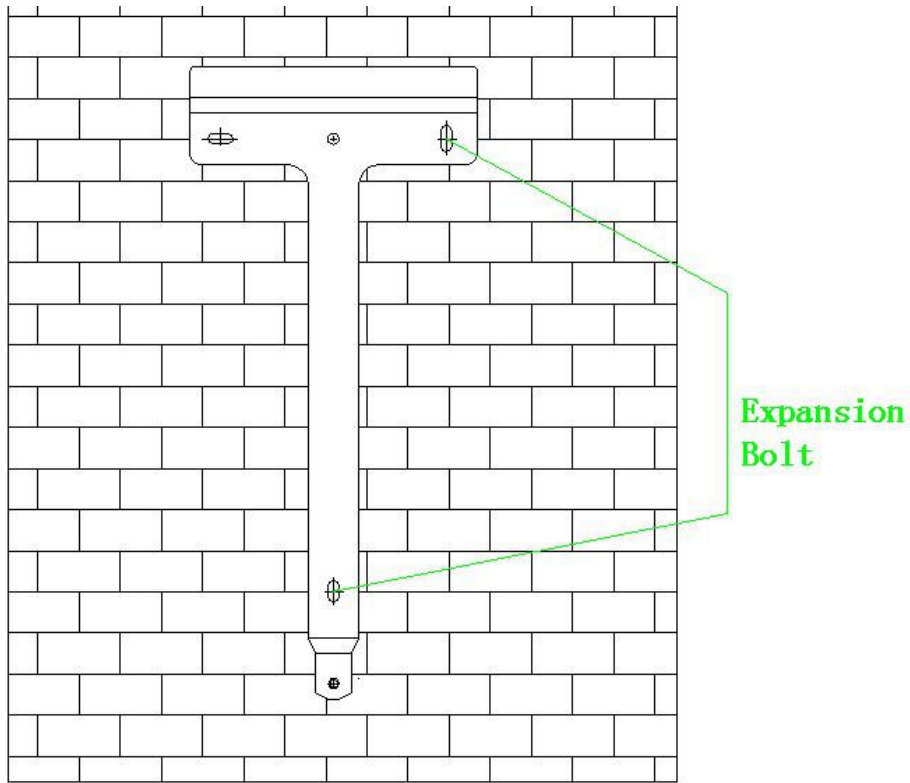

① Wall hanging installation

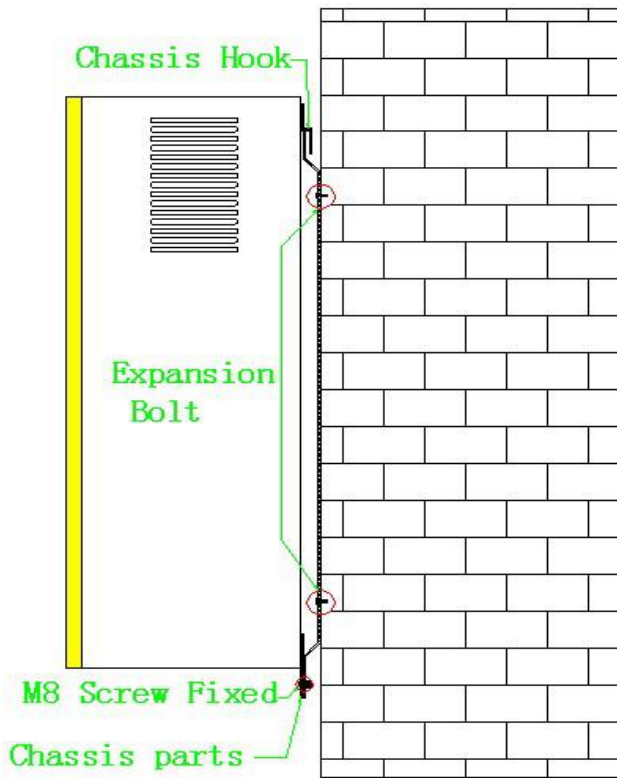

② Wall hanging installation diagram

## VII Remove wiring step controller

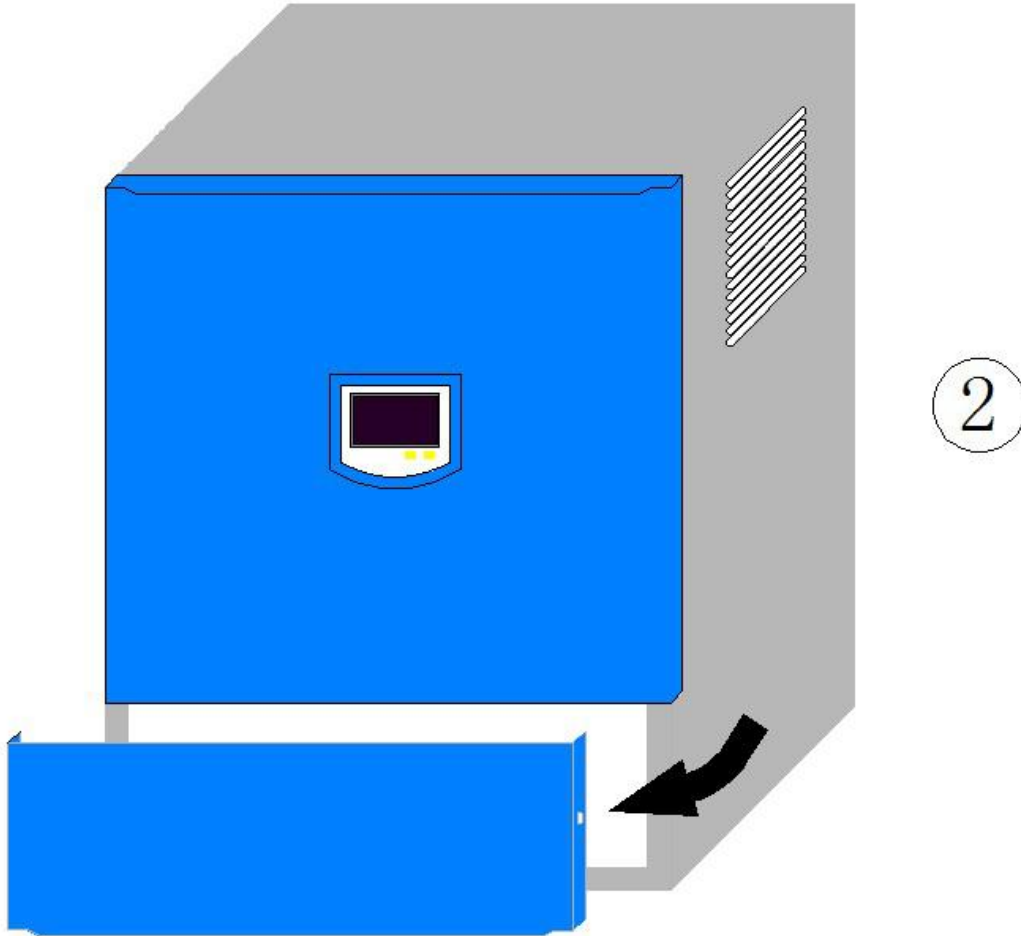
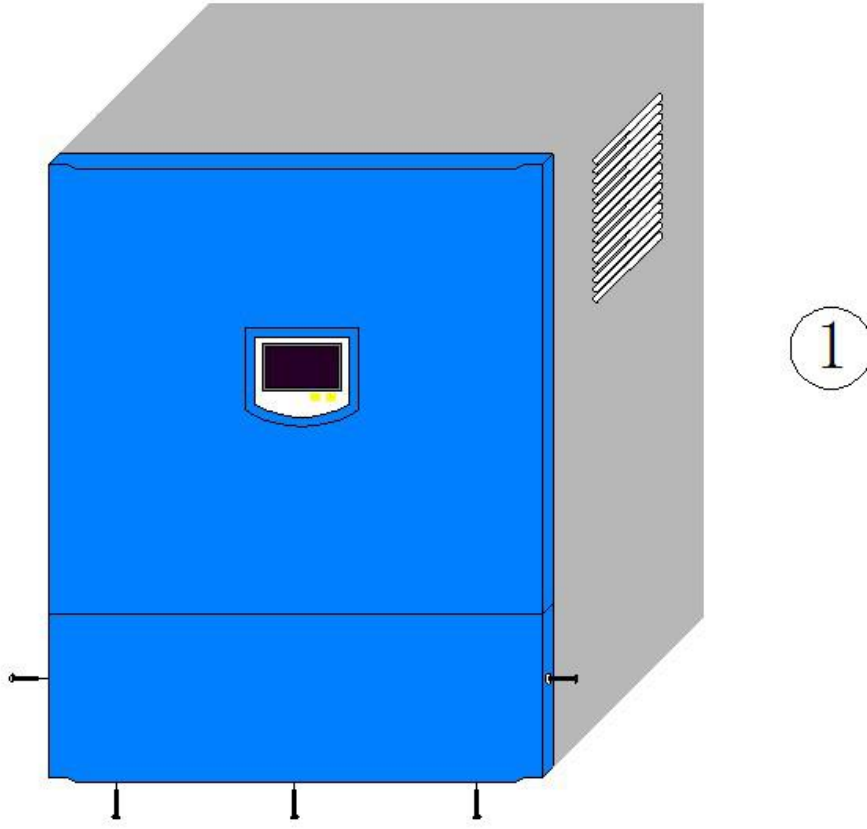

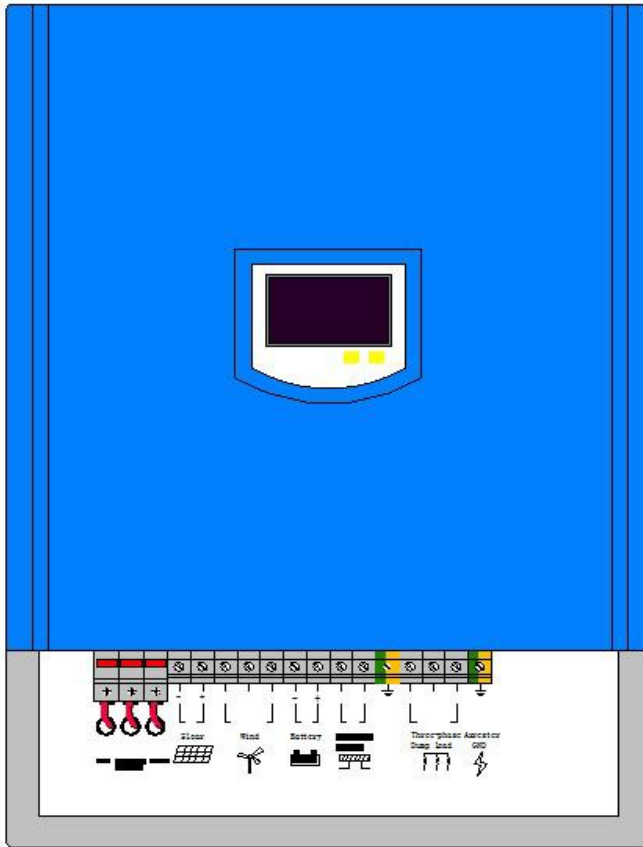

3

## VIII Failure Analysis

1. When the wind turbine is running normally but the controller makes the repeated pi-pa noises (or the wind turbine can not work), the wind turbine shall be turn off immediately to check whether the fuse is blown, the battery is connected well or the battery is damaged.
2. After the battery is connected, but the wind turbine can not work and there is no indicator, check whether the charging fuse is blown, the battery is connected well, the electrode is misconnected or the battery is damaged.

## IX Box diagram

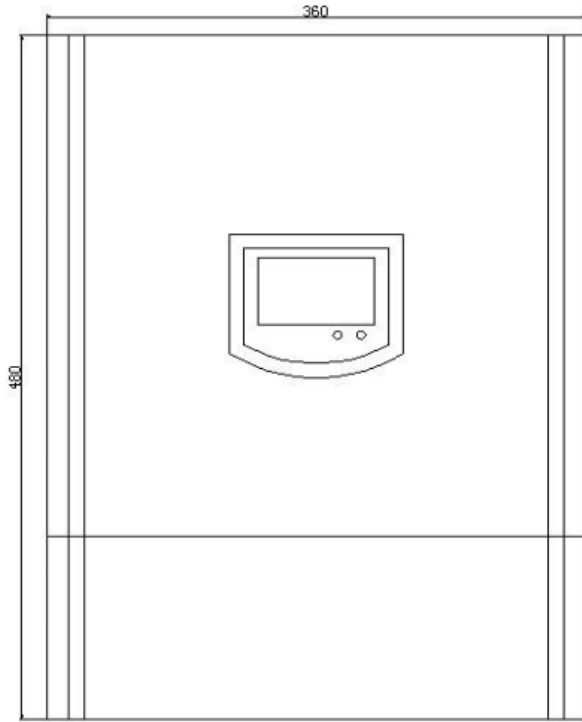

(360\*480)

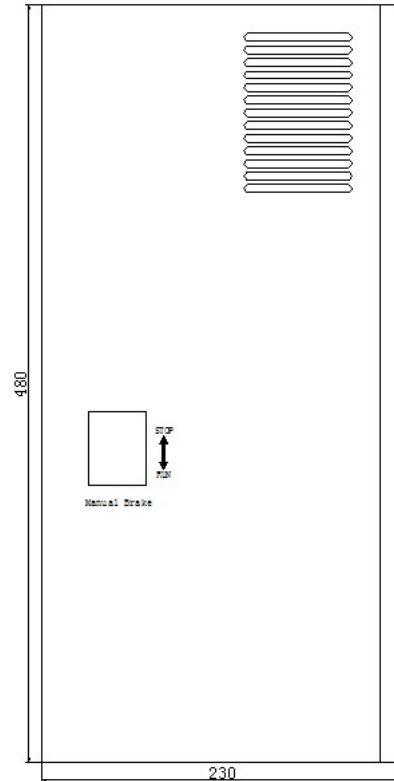

(230\*480)

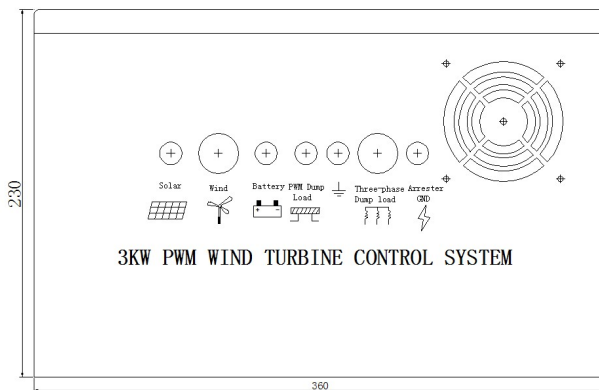

(230\*360)

## X Liquid crystal screen operation and display

### 1. Operation explanation



Striking the front panel of the case, LCD screen light. Each knock, parameters change again. Stop the operation 1 minute, LCD screen automatically put out, to save electricity.

### 2. Display explanation

LCD screen complete content

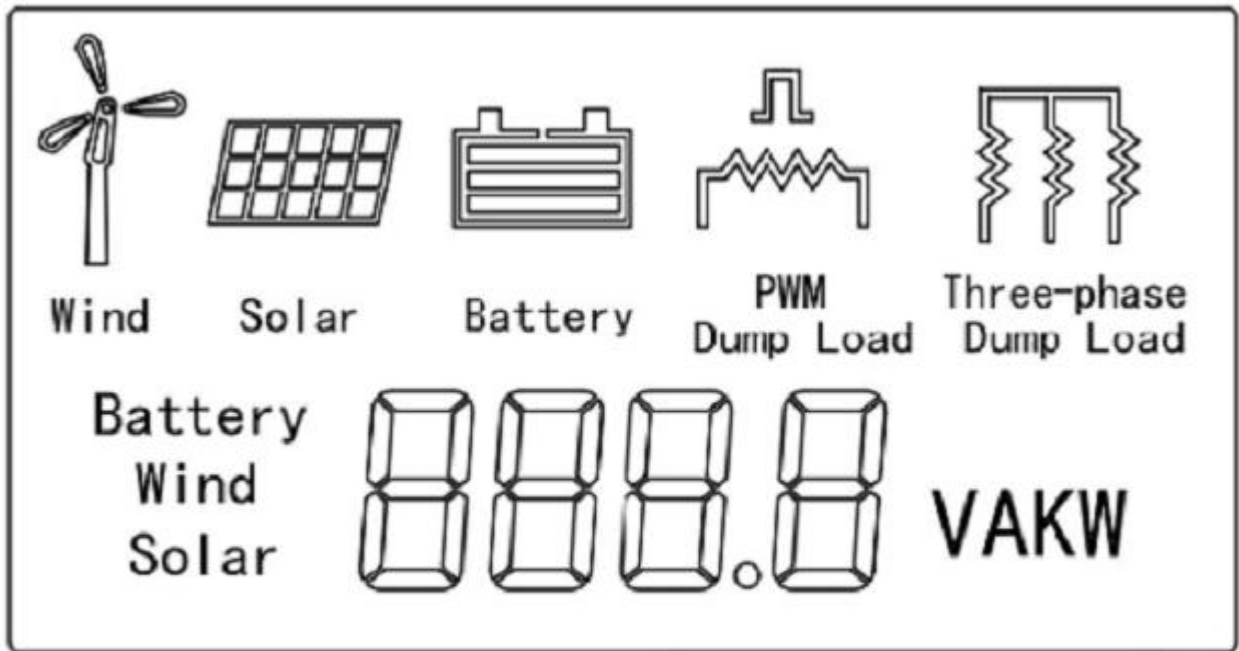

Image



Wind

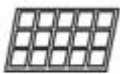

Solar

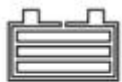

Battery

Explanation

Wind turbine

The wind turbine images display, showed that wind generators running normally.

Solar panel

The solar panels images display, showed that solar panels working normally.

Battery

Battery internal strip graphics, showed battery power.

When the battery charged enough, the battery voltage reached 125% of the rated voltage. The wind turbine will automatically carry out three-phase dump load discharging to stop charging. The 3 strip graphics in battery box all display.

When the battery voltage drops to 108% of the rated voltage, the wind turbine recovers to charge the battery.

When the battery voltage is too low, the frame of the battery image will flashing, remind users battery is low voltage, at

this time, please stop using battery, to charge battery, until stop flashing, just can be used.

### PWM dump load



In the conditions of strong or super-strong wind, battery charged by the wind turbine generator under constant voltage and current. Then this image display. When voltage of the battery drops to 108% of the rated voltage, the image not displayed.

### Three-phase dump load



When the battery is full (the battery pressure reaching 125% of the rated pressure), the controller will automatically carry out three-phase dump load discharging to stop charging battery. Then this image display.

When the battery voltage reduces to 108% of the rated pressure, the three-phase dump load will stop discharging to automatically recover battery charging. Then the image not displayed.

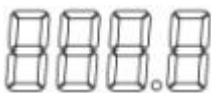

### Fuse burn

LCD display in digital form show the parameters value.

Fuse burn indicator light, when fuse burn, remind users replace the fuse.

### Polarity Reverse

Polarity Reverse indicator light, when the battery polarity reversed. Remind users properly connected to the battery.

## 3. LCD display parameters browse

(1) After plus electric, system is in viewing conditions, LCD display battery voltage: Battery XXX.XV.

(2) In viewing conditions,  striking the front panel of the case, will according to the following order cyclic display parameters.

Battery voltage → charge current → charge power → Wind turbine voltage → Wind turbine charge current → Wind turbine power → Solar panel voltage → Solar panel charge current → Solar panel power → Battery voltage.

## **XI Attentions**

We have taken full consideration of possibilities of occurring all kinds of accidents in design of the machine and adopted relative protective measures. But there is no perfect protective measure. Frequent use of some functions (e.g.: short-circuit protection, battery reverse connection protection) can cause great damage to the internal components of the machine. So, users shall not depend on these protective measures. The following attentions are very important for prolonging the service life of the machine:

1. Failures can be caused by many main reasons, among which are exhaustion of battery or battery group and poor contact.

- In the charging process, exhausted battery or poor contact of the battery can cause over voltage or low voltage; Frequent unload and braking can lead to damage of the controller.

- It is suggested that the capacity of the battery be checked periodically (with specific measuring tools instead of universal meter). Each and every battery shall go through checks of the capacity, contact condition and timely erasing of rust on the terminals of positive and negative electrodes. (The checks shall be done when the wind turbine is in brake state.)

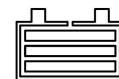

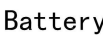
- The battery voltage drop to less than 85% rated voltage,  the frame of the battery image will flashing, remind users battery is low voltage, at this time, should stop used immediately, timely to charge battery. Otherwise, battery will damaged.

● This machine can not charge the exhausted or damaged battery. When voltage of the battery is 75% lower than the rated voltage, replace the battery in time or charge the battery separately.

2. The maintenance-free battery shall be maintained periodically in accordance with user manual of the maintenance-free battery.



3. Misconnection of the electrode of the battery is forbidden.



4. Owing to the unloader equipped on this machine can produce high temperature in working , please put it in the place with better ventilation and heat dispersion and 2 meters away from the host and where the man or livestock can not reach. Covering with other objects or using it under the flammable or explosive gas environment is forbidden to prevent fire.



5. The machine should be managed by professionals for your safety. It should be grounded reliably to resist electric shock. The ground resistance should be less than  $1\Omega$  and the connecting wire should be larger than  $10^2\text{mm}$ .

## **XIIMaintenance of Battery**

Maintenance of battery is a key link in work. Different maintenance methods are used to different kinds of batteries or battery series. For the lead-acid battery (except the maintenance-free type), the following attentions shall be paid in routing maintenance:

1. Keep the battery clean always;
2. Prevent any external impurities dropping into the battery;
3. All the tools and materials shall be stored in clean and sheltered place;
4. Sulphuric acid traces and dust on the entire battery must be cleaned periodically.
5. The contact devices and connecting wires among every single battery must be completely reliable.
6. If there is clogging up on sealing cap and vent hole, the vent hole shall be checked and wiped clearly.
7. Pay attention to the liquid height of the electrolyte. Don't let the pole plate and the partition board reveal on it.



8. The electrolyte shall be adjusted to normal density-(1.26-1.28) g/ cm<sup>3</sup>-(this parameter may be based upon the user manual) and this can only be done after battery charging is ended;
9. Check the battery terminal voltage and the density of electrolyte frequently and watch out for discharging process, and never allow the battery terminal voltage and the density of electrolyte to be lower than the degree which this battery discharging rule permits;
- 10.The electrolyte temperature shall not go beyond the rated value in the user manual, which is generally 45°C;
11. If the battery is laid aside for a long time, it shall be recharged each month to avoid excessive self-discharge and serious vitriolization.
12. Check the battery once a month, and replace those batteries which are damaged or with excessively low capacitance

### **X III Functional Diagram**

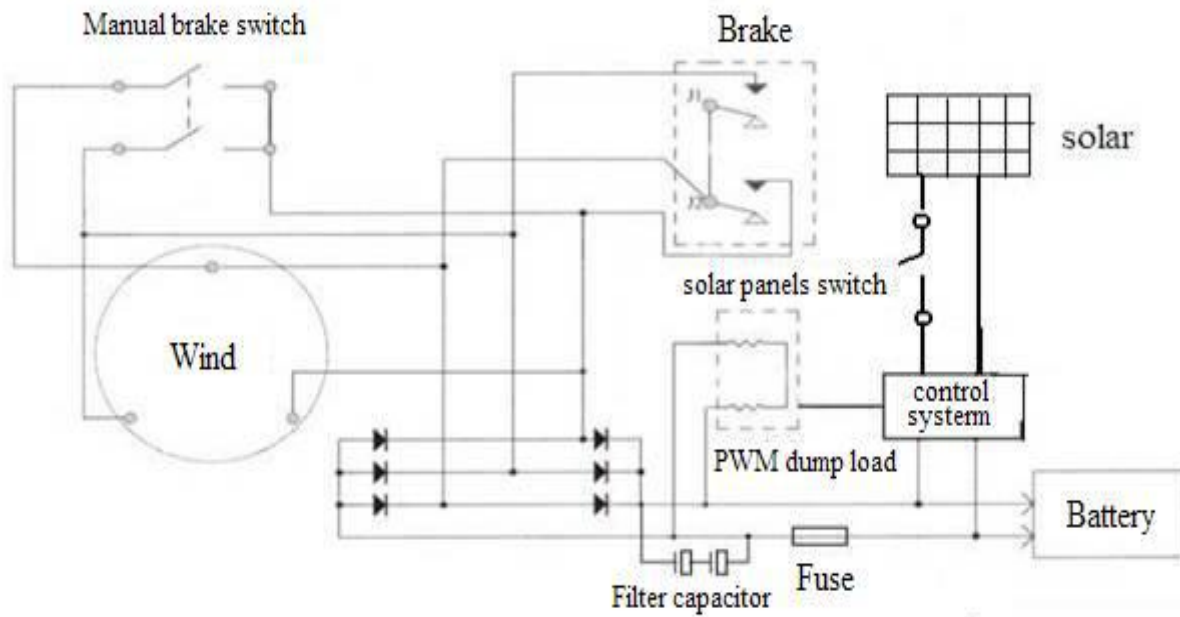

## XIV Wiring diagram

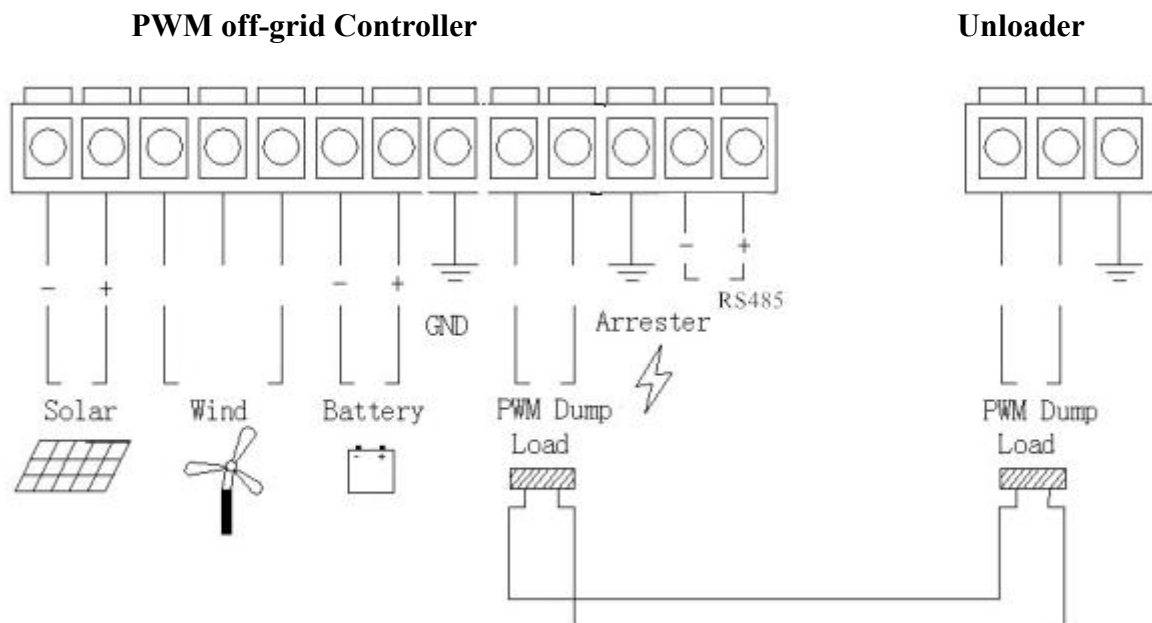

## XV Technical Parameters

Type	FKJ-B(PWM)-1.5KW48V(with 600W solar)
Wind turbine rated power	1.5KW
Wind turbine max. power	3KW
Solar panel power	600Wp
Battery	48Vdc
Function	Rectifier,charge, control
Display mode	LCD
Display content	Wind turbine voltage, wind turbine current,

	wind turbine power, solar panel voltage, solar panel current, solar panel power, battery voltage, charge current
PWM constant pressure voltage	>58Vdc
3-phase load voltage of the wind turbine	60±1Vdc
Recovery charging voltage of the wind turbine	54±1Vdc
Solar controller stop charging voltage	58±1Vdc
Solar restore charge voltage	54±1Vdc
Low-voltage of the battery	40±1Vdc
Self-provided connecting wire of the battery	>10mm <sup>2</sup>
PWM fuse	50A
Solar fuse (circuit breaker)	16A
Charging fuse (circuit breaker)	50A
Work environment temperature	-30-60°C
Relative humidity	<90% No condensation
Noise (1m)	<40dB
Degree of protection	IP20 (Indoor)
Cooling method	Forced air cooling
*Communication interface (optional)	RS485/USB/GPRS/Ethernet
*Temperature compensation (optional)	-4mv/°C/2V,-35°C~+80°C, Accuracy:±1°C
Size of the controller (mm)	575*430*320
Weight of the controller	18 Kg
Size of the dump load (mm)	480*360*200
Weight of the dump load	6.5 Kg



**Warning: Dismantlement of the unloader in the use is forbidden. The unloader must be connected in accordance with the wiring diagram strictly. Otherwise the wind turbine will be damaged because loss of control and the controller will be damaged due to the over-high voltage!**

### Particular Notice

When you connect wires on the controller, please indeed use the multi-brand BVR cable.